



## FLASH

Davide Groppi / 2017

It is our Infinito model turned around, with the light flowing downwards.  
The 9 mm wide stainless steel strip can run perfectly up to 36 metres in length  
(standard versions at 6 / 12 / 18 metres in length).

The ideal solution for direct illumination of spaces with very high ceilings.  
Its name pays homage to the famous comic book superhero,  
who can run seven times the speed of light.

Luminaire designed also to be powered by ENDLESS system.

È la declinazione del nostro modello Infinito, ma con la luce diretta verso il basso.  
Il nastro in acciaio inossidabile, largo 9 millimetri, può essere teso perfettamente  
fino a 36 metri di lunghezza (lampada standard 6 / 12 / 18 metri).

La soluzione ideale per l'illuminazione diretta di spazi di grande altezza.

Il nome è un omaggio al leggendario supereroe dei fumetti.

Famoso perché corre sette volte più veloce della luce...

Apparecchio illuminante alimentabile anche con il sistema ENDLESS.

How to order - FLASH 6

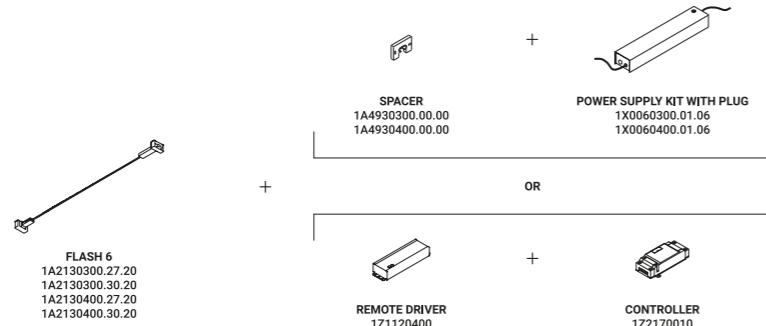

How to order - FLASH 12

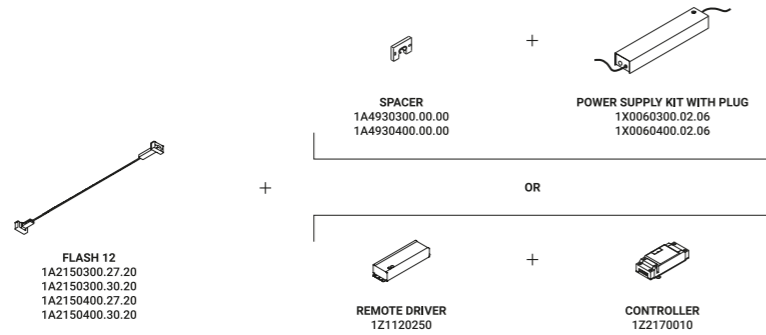

How to order - FLASH 18



Wall-Systems / Direct / Indoor

Material Metal  
Finish .03 Matt White .04 Matt Black

**Note** Special stainless steel tape (9 mm) running from wall to wall. Available in 6 / 12 / 18 m with a single power unit and uniform lighting. Available in Dual emission (DE) and Tunable White (TW - 5 / 10 m) versions. LED strip that can be divided every 96,6 mm. DE versions are available with dual on/off (two drivers required). FLASH 6 and FLASH 12: possibility for the luminaires to be powered by ENDLESS system (Max 48V DC - Max 150W - Max 4A) and to be used, on the same circuit, with the ENDLESS models.

*Speciale nastro (9 mm) in acciaio inox teso da parete a parete. Disponibile da 6/12/18m con un'unica alimentazione e illuminamento uniforme. Disponibile in versione a Doppia Emissione (DE) e in versione Tunable White (TW - 5 / 10 m). Strip LED sezionabile ogni 96,6 mm. Le versioni DE sono realizzabili con doppia accensione (necessari due driver). FLASH 6 e FLASH 12: apparecchi illuminanti alimentabili anche con il sistema ENDLESS (Max 48V DC - Max 150W - Max 4A) ed utilizzabili, sullo stesso circuito, con i modelli ENDLESS.*

**FLASH 6**  
57W - 1,48A  
48V DC  
2700K - 6576lm / 3000K - 6708lm  
CRI >90  
Driver not included  
CE IP20 E

Matt White - 2700K	1A2130300.27.20
Matt White - 3000K	1A2130300.30.20
Matt Black - 2700K	1A2130400.27.20
Matt Black - 3000K	1A2130400.30.20

**FLASH 12**  
114W - 2,61A  
48V DC  
2700K - 13152lm / 3000K - 13416lm  
CRI >90  
Driver not included  
CE IP20 E

Matt White - 2700K	1A2150300.27.20
Matt White - 3000K	1A2150300.30.20
Matt Black - 2700K	1A2150400.27.20
Matt Black - 3000K	1A2150400.30.20

**FLASH 18**  
171W  
48V DC  
2700K - 19728lm / 3000K - 20124lm  
CRI >90  
Driver not included  
CE IP20

Matt White - 2700K	1A2900300.27.20
Matt White - 3000K	1A2900300.30.20
Matt Black - 2700K	1A2900400.27.20
Matt Black - 3000K	1A2900400.30.20

How to order -  
FLASH 6 DE

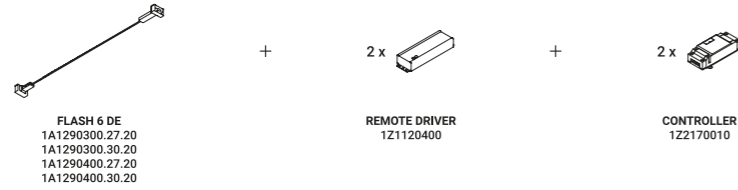

How to order -  
FLASH 12 DE

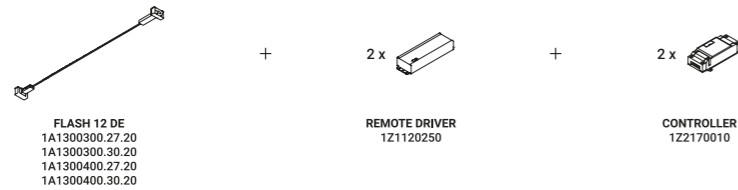

How to order -  
FLASH 18 DE

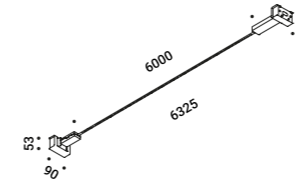
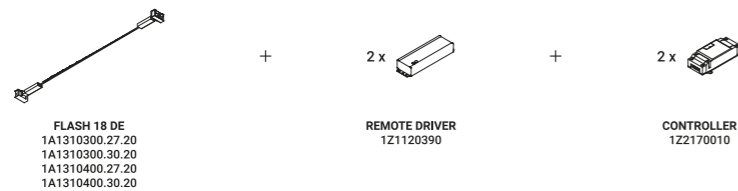

**FLASH 6 DE**

Dual emission  
114W  
48V DC  
2700K - Up 6576lm - Down 6576lm /  
3000K - Up 6708lm - Down 6708lm  
CRI >90  
Driver not included  
CE IP20

Matt White - 2700K  
Matt White - 3000K  
Matt Black - 2700K  
Matt Black - 3000K

1A1290300.27.20  
1A1290300.30.20  
1A1290400.27.20  
1A1290400.30.20

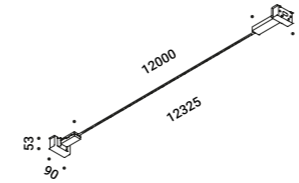

**FLASH 12 DE**

Dual emission  
228W  
48V DC  
2700K - Up 13152lm - Down 13152lm /  
3000K - Up 13416lm - Down 13416lm  
CRI >90  
Driver not included  
CE IP20

Matt White - 2700K  
Matt White - 3000K  
Matt Black - 2700K  
Matt Black - 3000K

1A1300300.27.20  
1A1300300.30.20  
1A1300400.27.20  
1A1300400.30.20

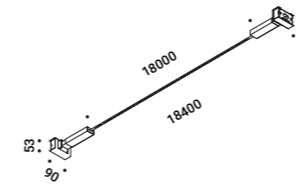

**FLASH 18 DE**

Dual emission  
342W  
48V DC  
2700K - Up 19728lm - Down 19728lm /  
3000K - Up 20124lm - Down 20124lm  
CRI >90  
Driver not included  
CE IP20

Matt White - 2700K  
Matt White - 3000K  
Matt Black - 2700K  
Matt Black - 3000K

1A1310300.27.20  
1A1310300.30.20  
1A1310400.27.20  
1A1310400.30.20

How to order -  
FLASH 5 TW

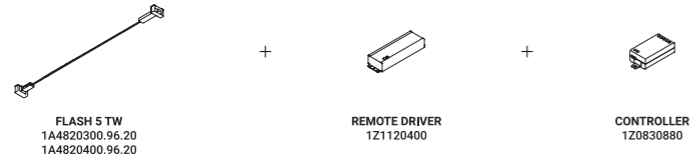

How to order -  
FLASH 10 TW

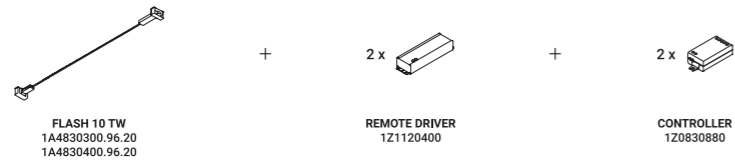

The sizes are expressed in millimeters.

**Note** Tunable White describes the variable colour temperature controls from warm white to cool white light. *Tunable White è la regolazione variabile della temperatura di colore della luce dalla tonalità calda a quella fredda.*

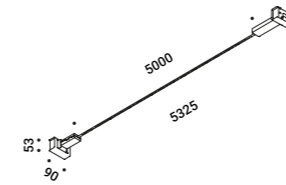

**FLASH 5 TW**  
Tunable White  
50W  
24V DC  
2700K / 6500K - 7650lm  
CRI >90  
Driver not included  
CE IP20

Matt White - 2700K / 6500K  
Matt Black - 2700K / 6500K

1A4820300.96.20  
1A4820400.96.20

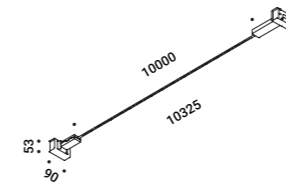

**FLASH 10 TW**  
Tunable White  
100W  
24V DC  
2700K / 6500K - 15300lm  
CRI >90  
Driver not included  
CE IP20

Matt White - 2700K / 6500K  
Matt Black - 2700K / 6500K

1A4830300.96.20  
1A4830400.96.20

How to order -  
FLASH 5 DE TW

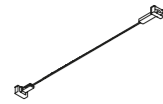

FLASH 5 DE TW  
1A4840300.96.20  
1A4840400.96.20

+



2 x

REMOTE DRIVER  
1Z1120400

+



2 x

CONTROLLER  
1Z0830880

How to order -  
FLASH 10 DE TW

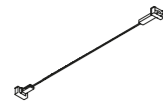

FLASH 10 DE TW  
1A4850300.96.20  
1A4850400.96.20

+



4 x

REMOTE DRIVER  
1Z1120400

+



4 x

CONTROLLER  
1Z0830880

**Note** Tunable White describes the variable colour temperature controls from warm white to cool white light. *Tunable White è la regolazione variabile della temperatura di colore della luce dalla tonalità calda a quella fredda.*

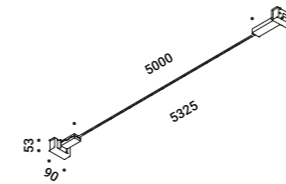

**FLASH 5 DE TW**  
Dual emission - Tunable White  
100W  
24V DC  
2700K / 6500K - 15300lm  
CRI >90  
Driver not included  
CE IP20

Matt White - 2700K / 6500K  
Matt Black - 2700K / 6500K

1A4840300.96.20  
1A4840400.96.20

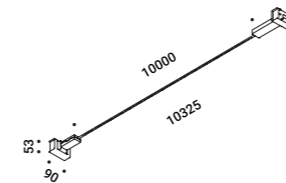

**FLASH 10 DE TW**  
Dual emission - Tunable White  
200W  
24V DC  
2700K / 6500K - 30600lm  
CRI >90  
Driver not included  
CE IP20

Matt White - 2700K / 6500K  
Matt Black - 2700K / 6500K

1A4850300.96.20  
1A4850400.96.20

## Compulsory accessories / Accessori obbligatori

## Drivers / Alimentatori

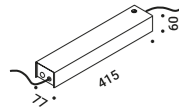

Driver with plug / Alimentatore con spina				Not included
Matt White	Input 100-240V - 50/60Hz Output 48V - Max 57W - IP20 Dimmer on board	FLASH 6	1X0060300.01.06	
Matt Black	Input 100-240V - 50/60Hz Output 48V - Max 57W - IP20 Dimmer on board	FLASH 6	1X0060400.01.06	

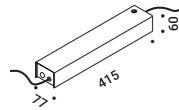

Driver with plug / Alimentatore con spina				Not included
Matt White	Input 100-240V - 50/60Hz Output 48V - Max 114W - IP20 Dimmer on board	FLASH 12	1X0060300.02.06	
Matt Black	Input 100-240V - 50/60Hz Output 48V - Max 114W - IP20 Dimmer on board	FLASH 12	1X0060400.02.06	

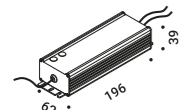

Driver / Alimentatore				Not included
100-240V	48V/80W/IP67/1-10V	FLASH 6 / FLASH 6 DE / FLASH 5 TW / FLASH 5 DE TW	1Z1120400	

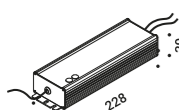

Driver / Alimentatore				Not included
100-240V	48V/150W/IP67/1-10V	FLASH 12 / FLASH 12 DE / FLASH 10 TW / FLASH 10 DE TW	1Z1120250	

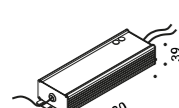

Driver / Alimentatore				Not included
100-240V	48V/240W/IP67/1-10V	FLASH 18 / FLASH 18 DE	1Z1120390	

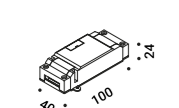

Controller				Not included
	DALI - PUSH - 0/1-10V - TRIAC - IP20	FLASH 6 / FLASH 12 / FLASH 18 / FLASH 6 DE / FLASH 12 DE / FLASH 18 DE	1Z2170010	

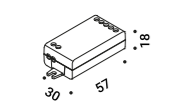

Controller Casambi - Tunable white				Not included
		FLASH 5 TW / FLASH 10 TW / FLASH 5 DE TW / FLASH 10 DE TW	1Z0830880	

## Optional accessories / Accessori opzionali

## Installation kits / Kit d'installazione



Spacer / Distanziale				Not included
Matt White	For driver kit with plug	FLASH 6 / FLASH 12	1A4930300.00.00	
Matt Black	For driver kit with plug	FLASH 6 / FLASH 12	1A4930400.00.00	



Ceiling installation kit / Kit d'installazione da soffitto				Not included
Matt Black			1A0080400.00.00	



Kit wall connection vertical sloped 45° / Kit attacco da parete per inclinazione verticale 45°				Not included
Matt Black			1A0120400.00.00	



Kit wall connection sloped right 75° / Kit attacco da parete per inclinazione 75° destro				Not included
Matt Black			1A0340400.00.00	



Kit wall connection sloped left 75° / Kit attacco da parete per inclinazione 75° sinistro				Not included
Matt Black			1A0350400.00.00	



Swallows / Rondini				Not included
Matt Black			1A0800400.00.00	

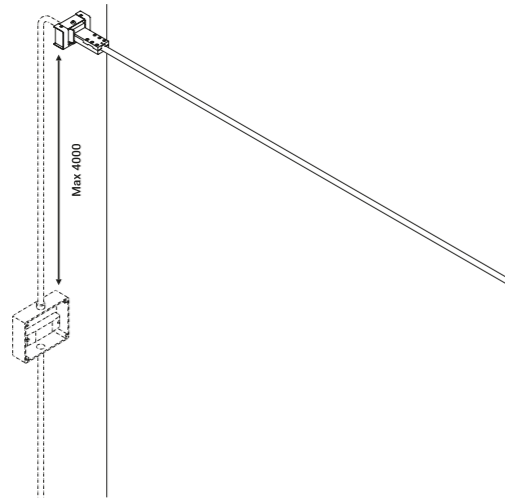

Example of installation with remote driver

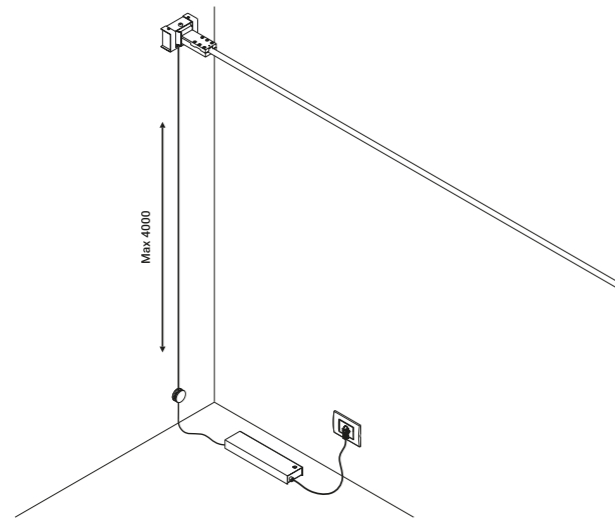

Example of installation with driver with plug



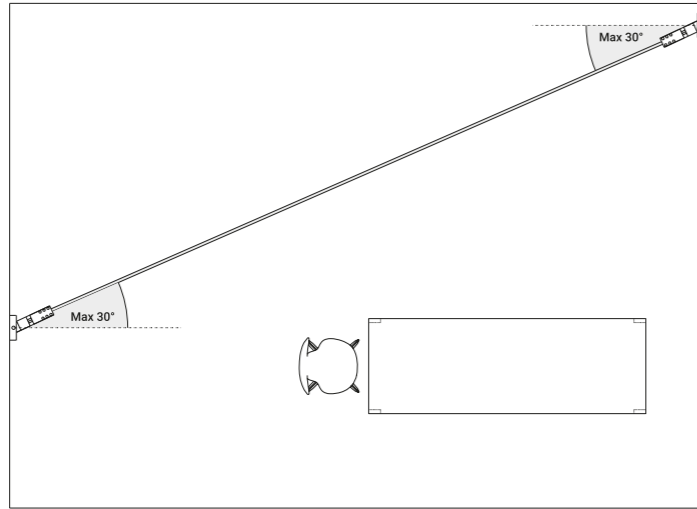

Example of installation with max rotation 30°

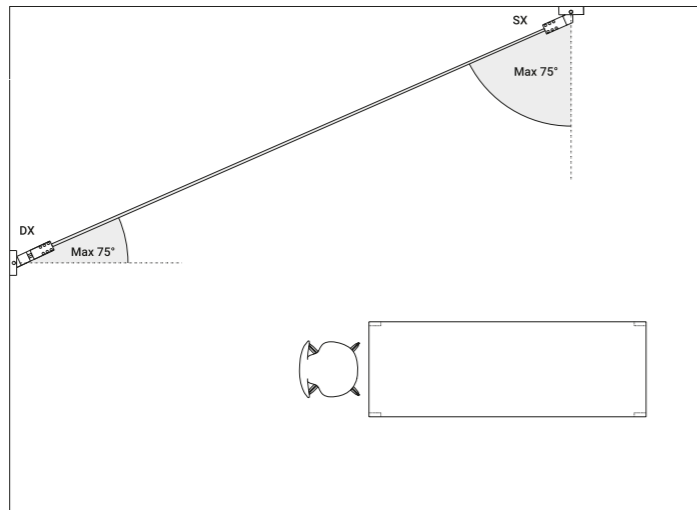

1A0340400.00.00 - 1A0350400.00.00 - Example of installation with kit wall connection sloped 75°

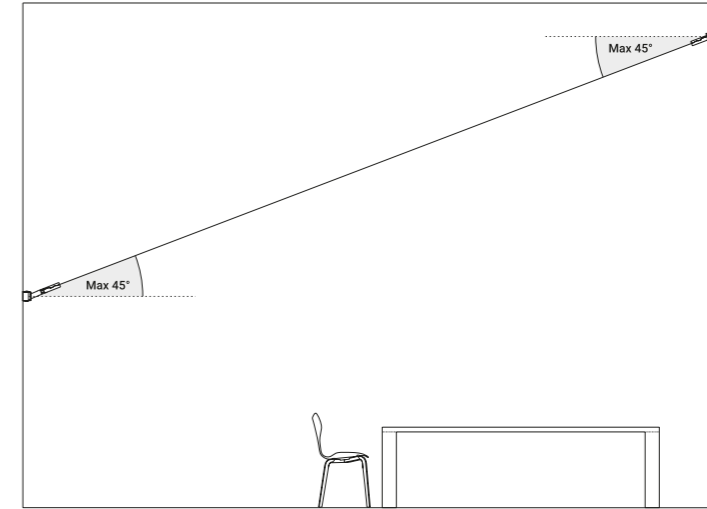

1A0120400.00.00 - Example of installation with kit wall connection vertical sloped 45°

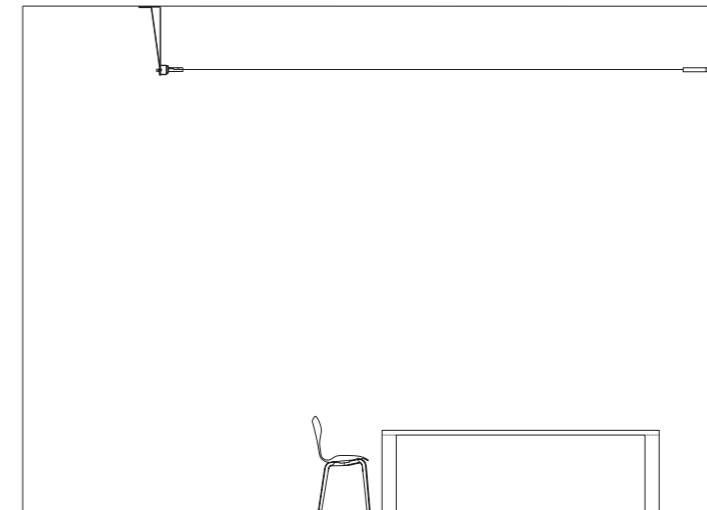

1A0080400.00.00 - Example of installation with ceiling installation kit