

## SOTTILE

Daide Groppi / 2023

A blade of light just 7 millimetres thick,  
the expression of that purest and most essential part of our thought.  
The surprise of an extremely thin, yet at the same time very bright, lamp.  
Luminaire designed also to be powered by ENDLESS conductive tape.

Una lama di luce spessa solo 7 millimetri,  
espressione di una parte del nostro pensiero, quello più puro ed essenziale.  
La sorpresa di una lampada estremamente sottile, ma al contempo molto luminosa.  
Apparecchio illuminante alimentabile anche con il tape conduttivo ENDLESS.

# SOTTILE

Davide Groppi / 2023

Suspension / Direct / Indoor

**Material** Metal  
**Finish** **.29** Brushed Bronze **.36** Brushed Black

**Note** Suspension luminaire. Matt white rose. AISI 304 stainless steel suspension cable. Black cable. Luminaire designed to be powered by our ENDLESS conductive tape and dedicated voltage/current (Max 48V DC - Max 150W - Max 4A). SOTTILE 1 DE and SOTTILE 2 DE: dual emission version. SOTTILE 2 and SOTTILE 2 DE: version with power cable only and without rose.

*Apparecchio illuminante a sospensione. Rosone bianco opaco. Cavo di sospensione in inox AISI 304. Cavo nero. Alimentabile anche con il tape conduttivo ENDLESS e tensione/corrente dedicata (Max 48V DC - Max 150W - Max 4A). SOTTILE 1 DE e SOTTILE 2 DE: versione a doppia emissione. SOTTILE 2 e SOTTILE 2 DE: versione con solo il cavo di alimentazione e senza rosone.*

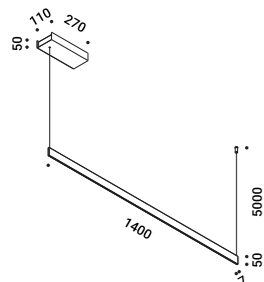

## SOTTILE 1

Ceiling driver version  
 22W  
 220-240V - 50/60Hz  
 2700K - 1692lm / 3000K - 1855lm  
 CRI >90  
 Driver integrated  
 DALI - PUSH - 1-10V - TRIAC

CE IP20

Brushed Bronze - 2700K - DALI - PUSH - 1-10V - TRIAC	1A4232900.27.05
Brushed Bronze - 3000K - DALI - PUSH - 1-10V - TRIAC	1A4232900.30.05
Brushed Black - 2700K - DALI - PUSH - 1-10V - TRIAC	1A4233600.27.05
Brushed Black - 3000K - DALI - PUSH - 1-10V - TRIAC	1A4233600.30.05

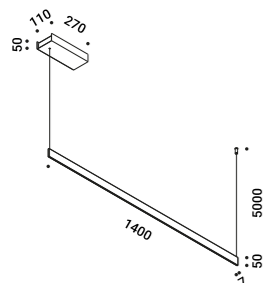

## SOTTILE 1 DE

Ceiling driver version - Dual emission  
 2x22W  
 120-240V - 50/60Hz  
 2700K - Up 1692lm - Down 1692lm /  
 3000K - Up 1855lm - Down 1855lm  
 CRI >90  
 Driver integrated  
 DALI - PUSH - 1-10V - TRIAC

CE IP20

Brushed Bronze - 2700K - DALI - PUSH - 1-10V - TRIAC	1A4642900.27.05
Brushed Bronze - 3000K - DALI - PUSH - 1-10V - TRIAC	1A4642900.30.05
Brushed Black - 2700K - DALI - PUSH - 1-10V - TRIAC	1A4643600.27.05
Brushed Black - 3000K - DALI - PUSH - 1-10V - TRIAC	1A4643600.30.05

Davide Groppi / 2023

# SOTTILE

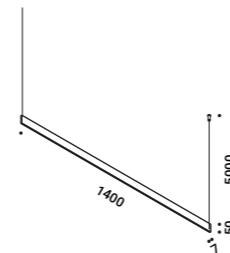

## SOTTILE 2

Remote driver version  
 19W  
 24V DC  
 2700K - 1692lm / 3000K - 1855lm  
 CRI >90  
 Driver not included

CE IP20 E

Brushed Bronze - 2700K	1A4232900.27.20
Brushed Bronze - 3000K	1A4232900.30.20
Brushed Black - 2700K	1A4233600.27.20
Brushed Black - 3000K	1A4233600.30.20

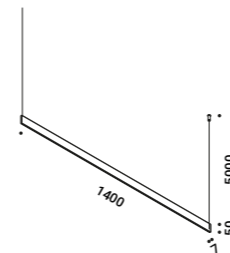

## SOTTILE 2 DE

Remote driver version - Dual emission  
 2x19W  
 24V DC  
 2700K - Up 1692lm - Down 1692lm /  
 3000K - Up 1855lm - Down 1855lm  
 CRI >90  
 Driver not included

CE IP20 E

Brushed Bronze - 2700K	1A4642900.27.20
Brushed Bronze - 3000K	1A4642900.30.20
Brushed Black - 2700K	1A4643600.27.20
Brushed Black - 3000K	1A4643600.30.20

## Compulsory accessories / Accessori obbligatori

Drivers / Alimentatori

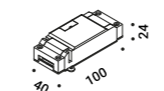
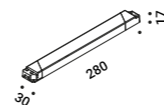

Driver / Alimentatore	Not included		
100-240V	24V/50W/IP20/ON/OFF	SOTTILE 2 / SOTTILE 2 DE	1Z1120490

Controller	Not included		
	DALI - PUSH - 0/1-10V - TRIAC - IP20	SOTTILE 2 / SOTTILE 2 DE	1Z2170010

Optional accessories / Accessori opzionali

Suspension kits / Kit di sospensione



Recessed suspension kit for 12,5 mm plasterboard / Kit di sospensione da incasso per cartongesso 12,5 mm				Not included
Matt White	For suspension cables - 1 Piece Plasterboard cut-out Ø 44 mm Minimum space for mounting 70 mm		1X0000300.01.00	
Matt Black	For suspension cables - 1 Piece Plasterboard cut-out Ø 44 mm Minimum space for mounting 70 mm		1X0000400.01.00	
Matt White	For electrical cables - 1 Piece Plasterboard cut-out Ø 44 mm Minimum space for mounting 70 mm	SOTTILE 2 / SOTTILE 2 DE	1X0000300.04.00	
Matt Black	For electrical cables - 1 Piece Plasterboard cut-out Ø 44 mm Minimum space for mounting 70 mm	SOTTILE 2 / SOTTILE 2 DE	1X0000400.04.00	



Ceiling suspension kit / Kit di sospensione da soffitto				Not included
Matt White	For suspension cables - 1 Piece		1X0010300.01.00	
Matt Black	For suspension cables - 1 Piece		1X0010400.01.00	
Matt White	For electrical cables - 1 Piece	SOTTILE 2 / SOTTILE 2 DE	1X0010300.04.00	
Matt Black	For electrical cables - 1 Piece	SOTTILE 2 / SOTTILE 2 DE	1X0010400.04.00	

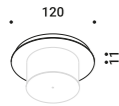

Wall adapter plate / Piastra di adattamento da parete				Not included
Matt White	For mounting on brick masonry walls		1X0050300.01.00	

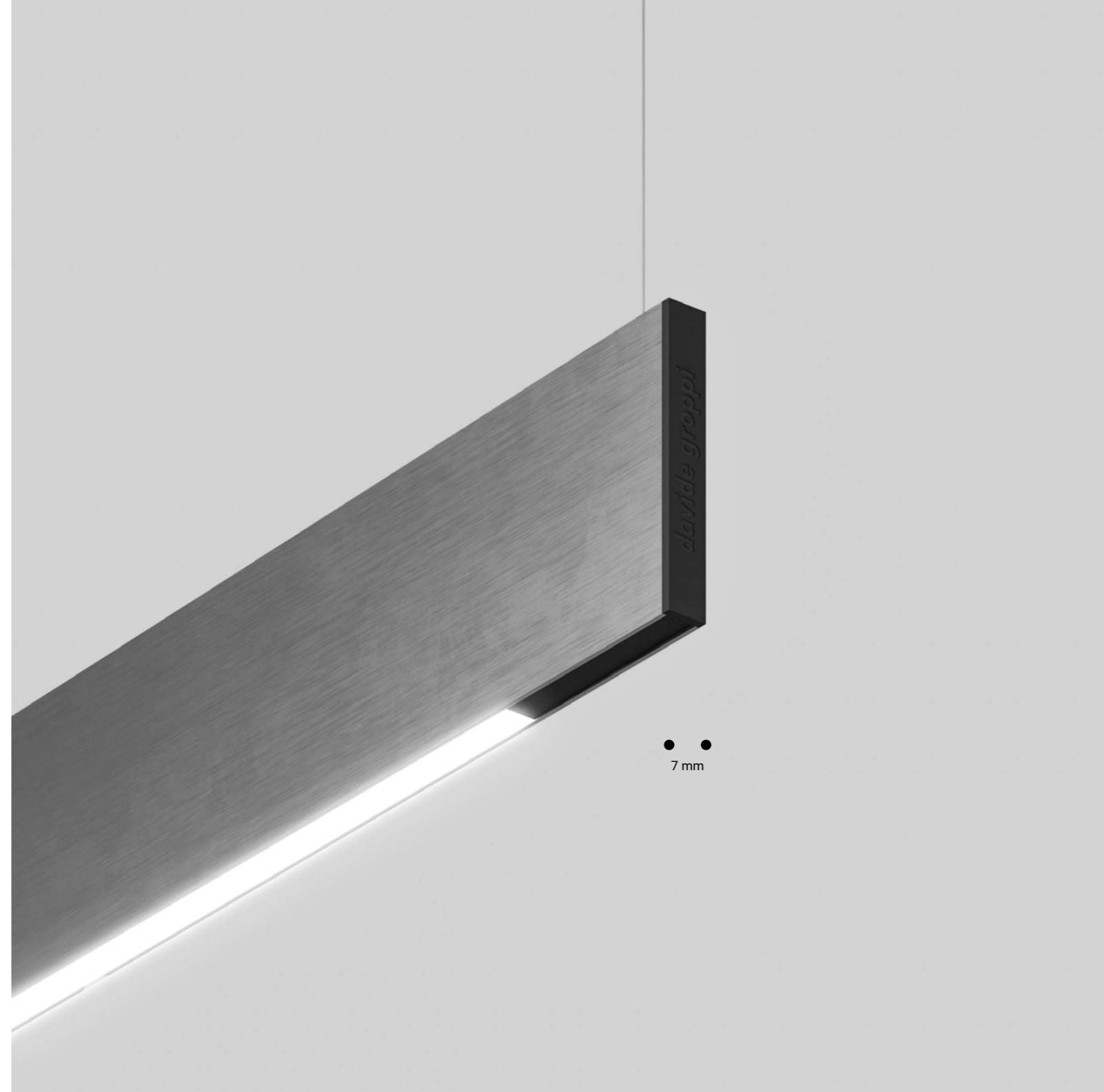

## SUSPENSION KITS / KIT DI SOSPENSIONE

Recessed suspension kit / Kit di sospensione da incasso

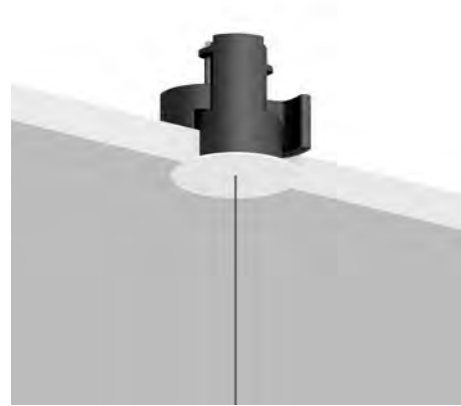

Suspension kit for 12,5 mm plasterboard  
Plasterboard cut-out Ø 44 mm  
Minimum space for mounting 70 mm

Kit di sospensione per cartongesso 12,5 mm  
Dimensioni taglio cartongesso Ø 44 mm  
Spazio minimo per incasso 70 mm

Magnetic fixing  
Fissaggio magnetico



Version	Use	Product reference	Finish	Code
Recessed suspension kit.01	For suspension cables	REFLEX S 1	Matt White	1X0000300.01.00
		REFLEX S 2		
		SHANGHAI 1		
		SHANGHAI 2	Matt Black	
		SOTTILE 1		
		SOTTILE 1 DE		
Recessed suspension kit.02	For electrical cables	MAGIA	Matt White	1X0000300.02.00
			Matt Black	1X0000400.02.00
Recessed suspension kit.03	For suspension cables	MASAI 1	Matt White	1X0000300.03.00
		MASAI 2	Matt Black	1X0000400.03.00
		SPY DE		
Recessed suspension kit.04	For electrical cables	ASINTOTO	Matt White	1X0000300.04.00
		REFLEX S 2	Matt Black	1X0000400.04.00
		SHANGHAI 2		
Recessed suspension kit.05	For electrical cables	LOUIS XIV 2	Matt White	1X0000300.05.00
		SOTTOSOPRA 2	Matt Black	1X0000400.05.00

## SUSPENSION KITS / KIT DI SOSPENSIONE

Ceiling suspension kit / Kit di sospensione da soffitto

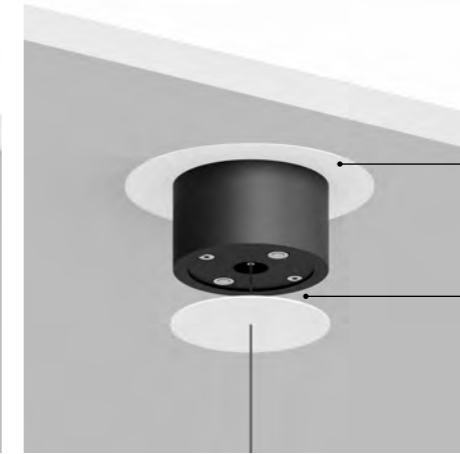

Back plate for masonry ceilings  
Back plate per soffitti in muratura

Magnetic fixing  
Fissaggio magnetico



Version	Use	Product reference	Finish	Code
Ceiling suspension kit.01	For suspension cables	REFLEX S 1	Matt White	1X0010300.01.00
		REFLEX S 2		
		SHANGHAI 1		
		SHANGHAI 2	Matt Black	
		SOTTILE 1		
		SOTTILE 1 DE		
Ceiling suspension kit.02	For electrical cables	MAGIA	Matt White	1X0010300.02.00
			Matt Black	1X0010400.02.00
Ceiling suspension kit.03	For suspension cables	MASAI 1	Matt White	1X0010300.03.00
		MASAI 2	Matt Black	1X0010400.03.00
		SPY DE		
Ceiling suspension kit.04	For electrical cables	ASINTOTO	Matt White	1X0010300.04.00
		REFLEX S 2	Matt Black	1X0010400.04.00
		SHANGHAI 2		
Back plate	For masonry ceilings		Matt White	1X0050300.01.00

